



LAIKA



1

2



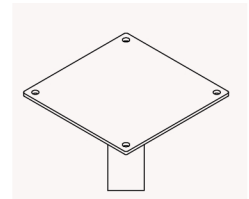
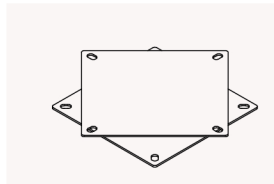
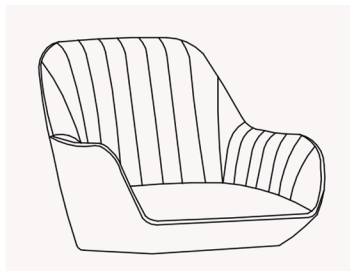

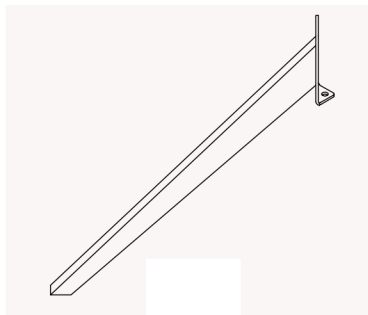

3



4



1	1 x
2	1 x
3	1 x
4	4 x

<p>A</p>  <p>5MM 1x</p>	<p>B</p>  <p>Ø14xØ6x1.5mm 8x</p>	<p>C</p>  <p>M6*16mm 10x</p>	<p>D</p>  <p>M6*10mm 4x</p>	<p>E</p>  <p>M6*13mm 2x</p>	<p>F</p>  <p>4x</p>
<p>G</p>  <p>Ø18xØ6x1.5mm 4x</p>					